

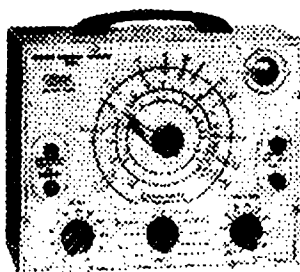

INSTRUCTION MANUAL

Model 950B



ELECTRONIC INSTRUMENT CO., Inc.

general description

The Model 950-B is a highly flexible ac-powered bridge which measures capacitance in the range from 10 mmf to 5000 mf and resistance from 0.5 Ω to 500M Ω on direct reading scales, employing an electron-ray ("magic eye") tube as a visual null indicator. Measurement of resistance, capacitance, and inductance by comparison with an external complementary standard is also possible, in which case a special ratio scale is read. An invaluable feature for service work is a dual-sensitivity leakage test employing a built-in source of polarizing voltage, continuously variable from 0 to 500 volts dc. The high sensitivity leakage test is used for testing paper, mica, and ceramic capacitors and the low sensitivity test for electrolytic capacitors. The electron-ray tube is the leakage indicator in both tests. In addition, this instrument provides direct power factor measurement on the higher capacity ranges in which electrolytics are measured. The Model 950-B, by the nature and accuracy of its testing and measurement facilities, will be found extremely valuable in the servicing of TV, fm-am radio, and other electronic equipment.

specifications

Capacity: 4 ranges	10mmf - 5000mmf 0.001mf - 0.5mf 0.1mf - 50mf 50mf - 5000mf
Resistance: 4 ranges	0.5 Ω - 500 Ω 50 Ω - 50,000 Ω 5000 Ω - 5 M Ω 5 M Ω - 500 M Ω
Comparator: 1 range	ratio from 0.05 to 20 (400 to 1)
DC Polarizing Voltage: (for leakage test)	0-500 volts continuously variable
Power Factor: 1 range	0-80%
Tube Complement:	1-1629, 1-6X5
Power Supply:	transformer operated half-wave rect.
Power Requirements:	105-125 volts AC, 50/60 cps
Overall Dimensions:	8" high, 10" wide, 4 3/4" deep
Weight:	10 lbs.

operation

PRELIMINARY: Plug the line cord into an ac outlet supplying 105-125 volts, 50/60 cps. Rotate the POWER FACTOR control clockwise from the "AC-OFF" position. Allow a 1-minute warm-up period, during which the electron-ray tube will slowly attain its characteristic green glow.

CONNECTIONS: The component to be measured or tested, whether it be

resistive, capacitive, or inductive, is always connected to the right-hand binding post. In the case of electrolytic capacitors, the positive lead must go to the plus binding post and the negative lead to the minus binding post. In comparison measurement, the standard component is connected to the left-hand binding posts, and, as usual, the unknown component is connected to the right-hand binding posts. If the component to be measured is connected in a circuit, it will be necessary to disconnect at least one side from the circuit so that the measurement will not be affected by other circuit components. To measure an extremely small capacitor, it will be necessary to remove it from the circuit entirely and connect it directly across the binding posts.

READING COMPONENT VALUES: In all component value measurements, whether made on the direct reading resistive and capacitive ranges or on the comparator range, the reading is made by setting the RANGE switch to the range including the expected value (comparator has only one range) and rotating the pointer knob to the point on the dial at which the bridge is balanced.

Balance is indicated as follows: When the bridge is far from balance, the entire target area of the electron-ray tube glows green with even a narrow, extra-bright sector resulting from "overlapping". As the pointer knob approaches the balance point, first the "overlapping" disappears and is replaced by a dark shadow sector. The closer the pointer knob approaches the balance point, the wider the shadow sector grows. If the balance point is passed the shadow sector will narrow down again. The position of the pointer knob at which the shadow angle is maximum is the balance point.

On the two highest capacitance ranges the power factor potentiometer is switched into the standard capacitor arm of the bridge to permit balancing of the internal series resistance frequently present in electrolytic capacitors. The "POWER FACTOR" knob must therefore be manipulated together with the pointer knob in order to achieve perfect bridge balance. The power factor control should be set at "0" while the pointer is rotated to obtain a capacitive balance. If the internal series resistance of the capacitor being measured is appreciable, the shadow angle at capacitive balance will be less than normal. When this occurs, the power factor control is rotated clockwise until the shadow angle reaches its normal maximum. The % power factor of the capacitor may be read on the power factor dial.

NOTE: Power factor is a measure of power dissipation in a capacitor due to its effective internal series resistance. In filter applications, power factor reduces the measured capacity as follows: At 20% p.f., C effective is 98% of C measured; at 30% p.f., C effective is 95% of C measured; at 50% p.f., C effective is 87% of C measured.

If the unknown capacitance or resistance is smaller than the minimum of the

range used, either balance will be obtained in the off-scale sector counter-clockwise from the lowest value marked on the dial or the shadow angle will widen to maximum only as the pointer knob approaches maximum counter-clockwise rotation (except on the expanded ranges). If the unknown capacitor is open or if the unknown resistor is shorted, the last-mentioned indication will be obtained even when the RANGE switch is set at the lowest capacitance or resistance range.

If the unknown resistance or capacitance is larger than the maximum of the range used, either balance will be obtained in the off-scale sector clockwise from the largest value marked on the dial or the shadow angle will widen to maximum only as the pointer knob approaches maximum clockwise rotation. If the unknown capacitor is shorted or if the unknown resistor is open, the last-mentioned indication will be obtained even when the RANGE switch is set at the highest capacitance or resistance range.

NOTE: To obtain the correct value of extremely small capacitors, the value of the distributed wiring capacity for your particular instrument should be subtracted from the reading obtained. This compensation is required in practically all instruments of this type. To measure the distributed wiring capacity, set the RANGE switch at the lowest capacity range ("10 mmfd - 5000 mmfd") and adjust the pointer knob carefully for exact bridge balance with nothing connected to the instrument terminals. You will have to observe the electron-ray tube very closely to determine just where the maximum shadow angle occurs. If the distributed wiring capacity readings is less than 10 mmf (off-scale) it can be safely ignored and no compensation need be made.

Interpretation of the reading on the ratio scale when the instrument is used as a comparator bridge depends upon the type of components being compared. When inductances or resistances are being compared, divide the known value of the standard by the reading on the ratio dial to obtain the value of the unknown. When capacitances are being compared, multiply the known value of the standard by the reading on the ratio dial to obtain the value of the unknown. It is unnecessary to use the comparator range for measurement of resistances and capacitances falling into the direct measurement range of the instrument. However, for resistances and capacitors outside the direct measurement range and for certain chokes, transformers, speakers, and coils, the comparator method of measurement is very useful.

LEAKAGE TESTS

To test for leakage in paper, mica, or ceramic capacitors, set the RANGE switch at the "PAPER-MICA TEST" position. To test for leakage in electrolytic capacitors set the RANGE switch at the "ELECTROLYTIC TEST" position. In

both tests, start with the "VOLTAGE" control at "0". The capacitor in both tests is connected across the right-hand binding posts just as in capacitance measurements. Be certain that the positive lead of an electrolytic capacitor is connected to the binding post marked plus and the negative lead to the binding post marked minus. Otherwise, not only will the leakage test have no value, but the electrolytic may be seriously damaged. Observe the electron-ray tube and note that the shadow angle is at maximum, which is the "normal" or "no-leakage" indication in the leakage tests. Now turn the "VOLTAGE" control from "0" to the rated dc working voltage of the capacitor. The shadow angle should contract instantaneously as the capacitor charges and then slowly expand. If the shadow angle completely disappears and does not reappear, the capacitor is excessively leaky. The shadow angle need not expand to the maximum as before in order for the capacitor to check good. As these tests are very sensitive, a little leakage in capacitors with values above .1 mfd may result in only a small shadow angle reappearing. This is normal with a good capacitor and the reappearance of even a very small shadow angle means that the capacitor is good. Only complete failure of the shadow angle to reappear indicate an excessively leaky capacitor. CAUTION: Discharge the capacitor before disconnection from the instrument terminals by turning the "VOLTAGE" control down to "0".

Note on Leakage Testing of Electrolytic Capacitors: Initial leakage current in an electrolytic capacitor is a function of shelf life; it does not show the condition of the capacitor. When making the leakage test, enough time must be allowed for the leakage current to reach the normal value. The instructions of the capacitor manufacturers are to measure the leakage current of the capacitor at the rated dc voltage, after the rated dc voltage has been applied to the capacitor for five minutes plus one minute for each month of shelf storage.

circuit description

The operation of the Model 950-B may be best understood by examining the circuit formed at each position of the range switch. In each of the bridge circuits P1 varies the resistance in two arms. Capacitor C5 or C6, resistor R10, and the electron-ray tube V2 compose the null indicating circuit. The 54 volt winding is the secondary winding of the power transformer that supplies the ac power to operate the bridge. R1 is a current limiting resistor.

The B plus voltage required to power the electron-ray indicator and the negative dc voltage required for leakage testing of capacitors are obtained from the 6X5 tube (V1) connected as a half-wave rectifier, in conjunction with the high voltage secondary winding of the power transformer and the filter and voltage divider networks composed of R8, R7, P3, C1 and C9.

NOTE: The electron-ray indicator is preferable to headphone or a meter since

it may be used without disturbance from external noises and is capable of withstanding substantial overloading without damage.

Simplified schematic diagrams of the Model 950-B circuit at each position of the range switch are given below.

- Fig. 1. Bridge circuit for "10mmfd - 5000mmfd" range (C2) and ".001 mfd-.5 mfd" range (C3).
- Fig. 2. Bridge circuit for ".1mfd - 50mfd" range. P2 is required to balance the internal series resistance frequently present in electrolytic capacitors and is calibrated in % power factor.
- Fig. 3. Bridge circuit for "50mfd - 5000mfd" EXPANDED range. R2 expands capacitance measurement range as compared to circuit of Fig. 2.
- Fig. 4. Bridge circuit for ".5Ω - 500Ω" range (R4), "50Ω - 50,000Ω" range (R5), and "5000Ω - 5MΩ" range (R6).
- Fig. 5. Bridge circuit for "5MΩ - 500MΩ" EXPANDED range. R2 expands resistance measurement range as compared to circuit of Fig. 4.
- Fig. 6. Bridge circuit for "COMPARATOR" range.
- Fig. 7. Leakage check circuit in "PAPER-MICA TEST" position. R9 slows down charging process so that electron-ray tube action will not be too fast for detection by the operator.
- Fig. 8. Leakage check circuit in "ELECTROLYTIC TEST" position. Note that R11, 2.2KΩ, provides reduced electron-ray tube sensitivity as compared to the circuit of Fig. 7.

replacement parts list

Stock#	Sym.	Description	Am't.	Stock#	Sym.	Description	Am't.
23006	C1	cap., elec 8mfd-525V... 1	1	11002	R4	res., 20Ω, 1/2W, 1% . 1	1
21500	C2	cap., 200mmf, prec. ... 1	1	11011	R5	res., 2KΩ, 1/2W, 1% . 1	1
20500	C3	cap., .02mf, prec. ... 1	1	11026	R6	res., 200KΩ, 1/2W, 1% . 1	1
20501	C4	cap., 2mf, prec. 1	1	10803	R7	res., 3.3KΩ, 1W ... 1	1
20000	C5,6,7	cap., .01mf, 400V ... 3	3	10848	R8	res., 68KΩ, 1W 1	1
20015	C8	cap., .25mf-600V ... 1	1	10027	R9	res., 270KΩ, 1/2W ... 1	1
23008	C9	cap., elec 4mfd-250V... 1	1	10037	R10	res., 10MΩ, 1/2W ... 1	1
17000	P1	pot., 10KΩ 1	1	10818	R11	res., 2.2KΩ, 1W 1	1
18007	P2	pot., 1KΩ w/SPST 1	1	10028	R12	res., 470K, 1/2W ... 1	1
19005	P3	pot., 100KΩ, 4W 1	1	60030	S1	switch, range 1	1
10752	R1	res., 500Ω, 4W 1	1	30005	PT1	transformer, power ... 1	1
11027	R2	res., 250K, 1/2W, 1% . 1	1	90009	V1	tube, 6X5 1	1
10030	R3	res., 1MΩ, 1/2W, ... 1	1	90015	V2	tube, 162? 1	1

NOTE: If your instrument fails to function properly and the cause of trouble is not apparent, you may return it to the EICO repair department where it will be repaired at a charge of \$3.50 plus the cost of parts. If possible, ship by Railway Express. Return shipment will be made express collect.

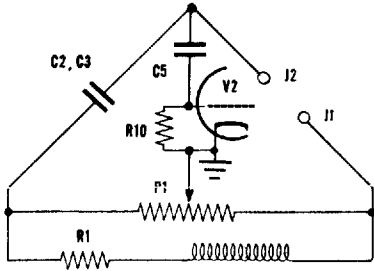

Fig. 1

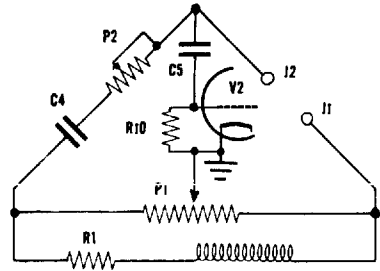

Fig. 2

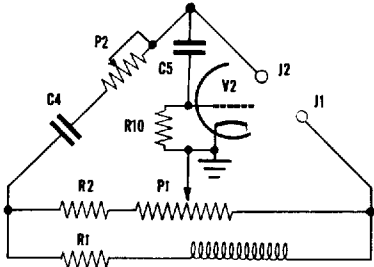

Fig. 3

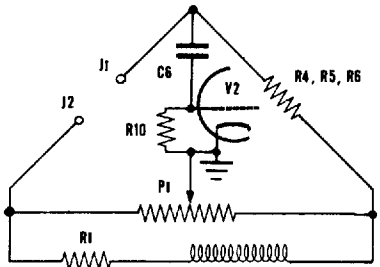

Fig. 4

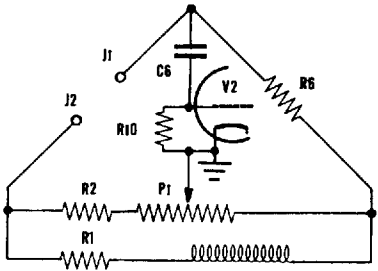

Fig. 5

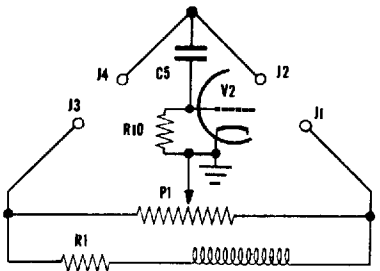

Fig. 6

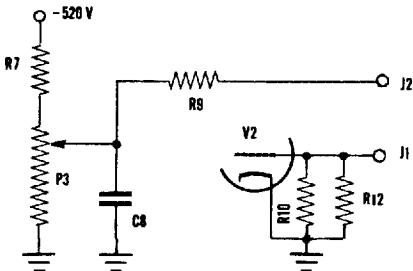

Fig. 7

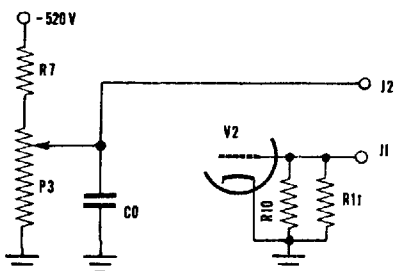
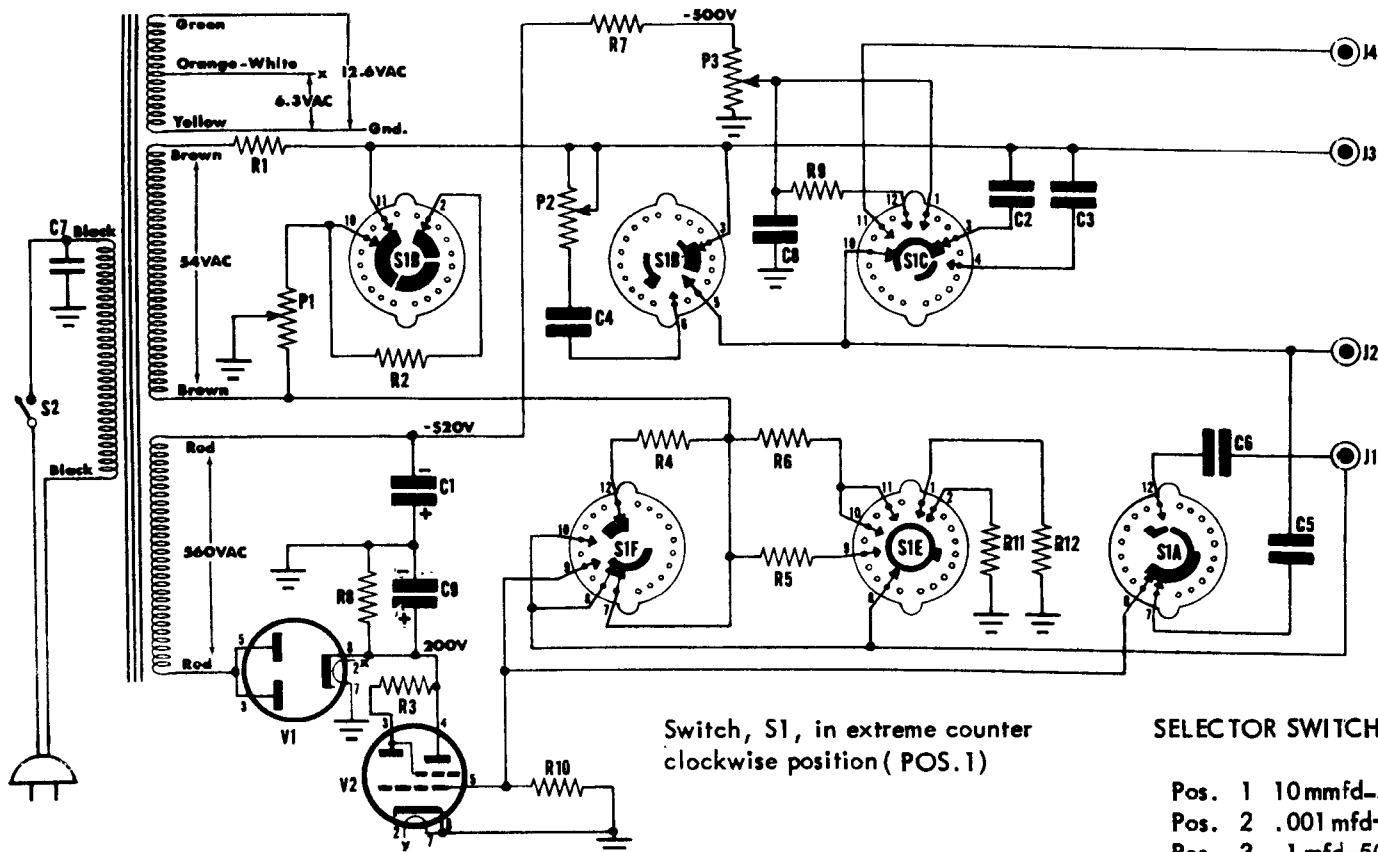

Fig. 8



Switch, S1, in extreme counter clockwise position (POS. 1)

SELECTOR SWITCH POSITIONS

- Pos. 1 10 mmfd-5000 mmfd
- Pos. 2 .001 mfd-.5 mfd
- Pos. 3 .1 mfd-50 mfd
- Pos. 4 50 mfd-5000 mfd
- Pos. 5 .5 Ω - 500 Ω
- Pos. 6 50 Ω - 50K Ω
- Pos. 7 5K Ω - 5M Ω
- Pos. 8 5M Ω - 500M Ω
- Pos. 9 Comparator
- Pos. 10 Paper-Mica Test
- Pos. 11 Electrolytic Test

Sym.	Description	Sym.	Description	Sym.	Description
C1	cap., elec 8mfd-525V	P3	pot., 100KΩ, 4W	R9	res., 270KΩ, 1/2 W
C2	cap., 200mmf, prec.	R1	res., 500Ω, 4 W	R10	res., 10MΩ, 1/2 W
C3	cap., .02mf, prec.	R2	res., 250KΩ, 1/2W, 1%	R11	res., 2.2KΩ, 1W
C4	cap., 2 mf, prec.	R3	res., 1MΩ, 1/2 W	R12	res., 470K, 1/2 W
C5,6,7	cap., .01 mf-400V	R4	res., 20Ω, 1/2 W, 1%	S1	switch, range
C8	cap., .25mf-600V	R5	res., 2KΩ, 1/2 W, 1%	S2	switch, SPST, p/o P2
C9	cap., elec 4 mfd-250V	R6	res., 200KΩ, 1/2W, 1%	V1	tube, 6X5
P1	pot., 10KΩ	R7	res., 3.3KΩ, 1W	V2	tube, 1629
P2	pot., 1KΩ w/SPST	R8	res., 68KΩ, 1W		

MODEL 950B RESISTANCE-CAPACITANCE-COMPARATOR BRIDGE